

Model:H-BC230

★Specifications

Nominal Voltage		1.2V	Final Discharge Voltage	1.0V
Nominal Capacity		230mAh (minimum at 0.1C/ 0.2C)		
Dimensions	Diameter	25.0±0.1 (mm)		
	Height	6.3±0.2 (mm)		
Weight Approx.		8.6 g		
Internal Impedance at 1000Hz.		Approx. ≤500 mΩ at after charge		
Charge	Standard	0.1C (23mA) for 14~16 hrs		
	Rapid	0.2C (46mA) for 8 hrs		
	Trickle	0.03C (6.9mA)		
Temperature Range for Operation (Humidity: Max 85%)	Charge	Standard	0~+45°C	
		Rapid	+10~+45°C	
	Discharge		-10~+45°C	
	Storage		-20~+45°C (less than 1 month)	

★Dimensions

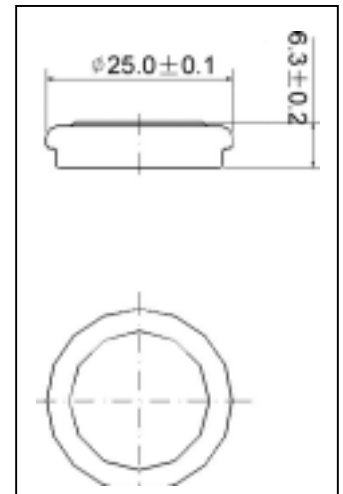

★Typical Characteristic

Typical Charge Curve (23mA)

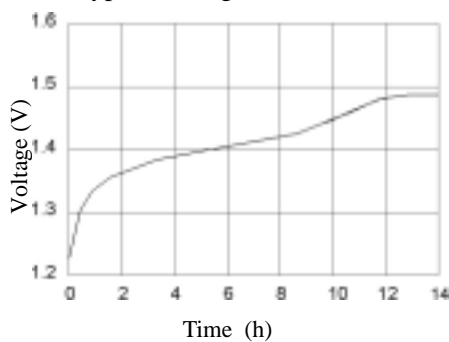

Typical Discharge Curve (46mA)

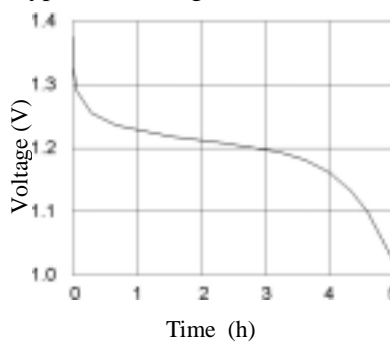

Cycle Life Curve

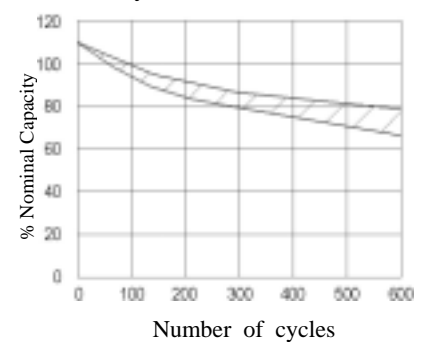

Typical Charge Curve at Various Currents

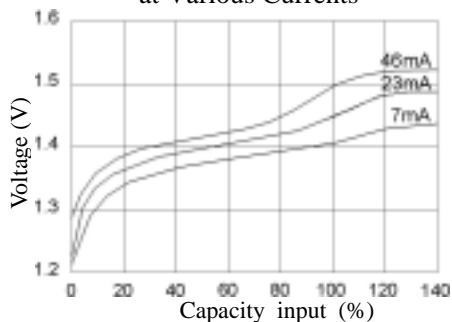

Discharge Curve at Various Temperatures (46mA)

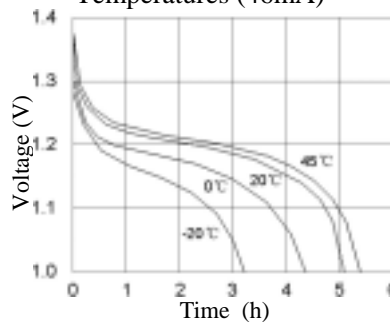

Self-Discharge Rate at Various Temperatures

