

Li-ion Cylindrical Battery Individual Data Sheets

L-C18650

Specifications

Nominal Voltage		3.7V	
Capacity ¹ (mAh)	0.2C Discharge		
	Minimum	1700mAh	
	Typical ³	1900mAh	
Dimen- Sions	Diameter	mm	inch
		18.3 ⁰ _{-0.3}	0.720 ⁰ _{-0.012}
	Height	64.8 ⁰ _{-0.5}	2.551 ⁰ _{-0.020}
Weight *		Grams	Ounces
		44	1.55
Internal impedance* at 1000Hz		<80m Ω (After charge)	
Charge	Standard	950mA(0.5C)×5hrs	
	Rapid	1900mA(1C)× 2.5hrs	
Ambient temperature	Charge	°C	°F
		0°C to 45°C	32°F to 113°F
	Discharge	-20°C to 60°C -4°F to 140°F	
	Storage	-20°C to 45°C -4°F to 113°F	

Charge characteristics

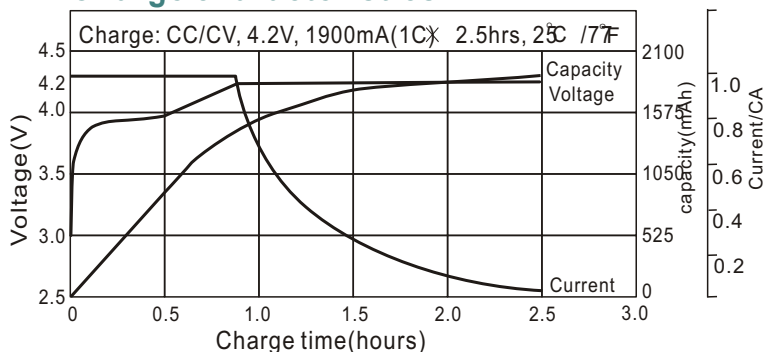

Discharge temperature characteristics

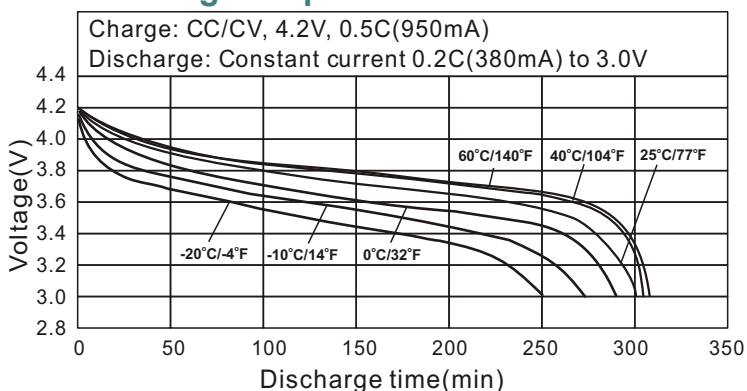

Dimensions(with tube)

(mm)

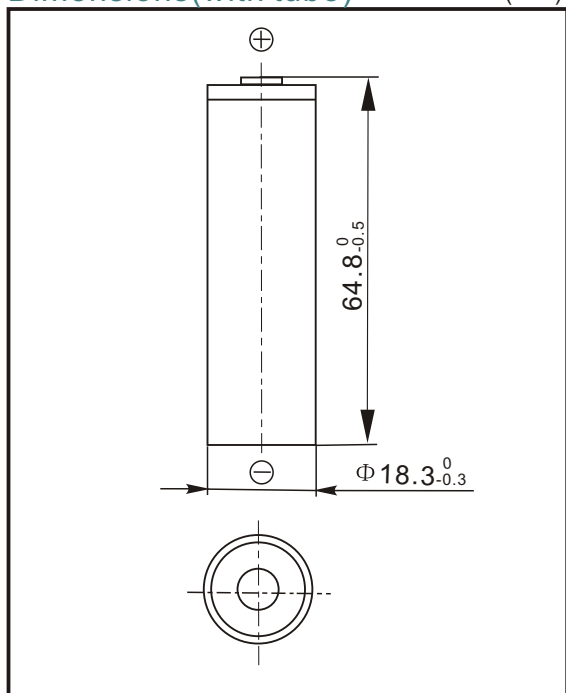

Cycle life characteristics

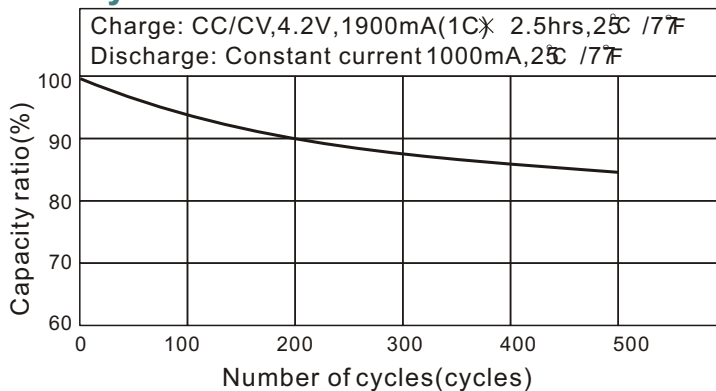

Storage characteristic

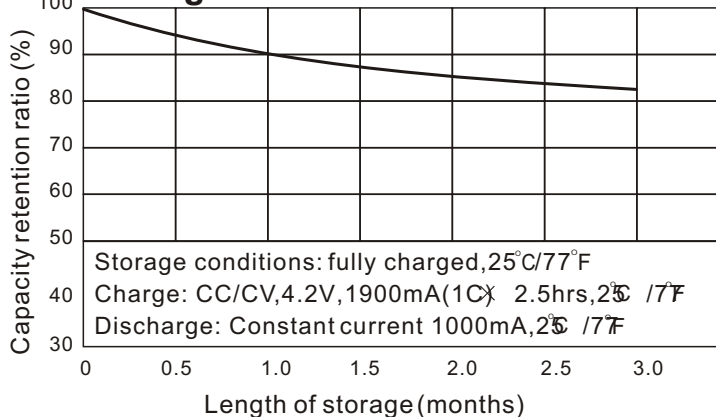

Note:

1. After charging at 1C for 2.5 hours.
 2. Nominal capacity, rated at 0.2C, 25°C/77°F.
 3. Average capacity. For reference only.
- *. Weight and internal impedance are for reference.